

NEW



COMPACT EXCAVATOR | 45z-1/48z-1/55z-1/57c-1

Operating weight: 9,886 lb (4,475 kg) – 12,087 lb (5,483 kg) Net engine power: 48 hp (36 kW)





45Z-1

All daily checks
and fuel fill at
ground level

55Z-1

100% steel
body work and
simplified H-frame
undercarriage.

48Z-1

Best-in-class 500
hour greasing
intervals.



THE LATEST ADDITIONS TO OUR NEW GENERATION

NEW GENERATION CONTROL, EFFICIENCY, PERFORMANCE, STRENGTH.

Control: Industry-leading digital screen technology to tailor and store machine settings.

Efficiency: Designed to minimize operating costs.

Performance: Greater bucket and dipper tearout, greater dump height and greater lift capacity.

Strength: The strongest 4-6 ton excavators on the market.

57C-1

Superb tear-out
and lift capacity.

NEW GENERATION STRENGTH.

JCB COMPACT EXCAVATORS LEVERAGE THE COMPANY'S 50-PLUS YEARS OF EXCAVATOR MANUFACTURING EXPERIENCE, AND ARE DESIGNED TO EXCEED CUSTOMER EXPECTATIONS FOR STRENGTH AND PERFORMANCE IN A COMPACT MACHINE.

The robot-welded boom and arm are made of high tensile steel, with internal baffle plates in the boom, for enhanced durability.



Built to last.

- 1 A simplified, heavy duty H-frame design is enhanced by finite element analysis to create a highly durable undercarriage.
- 2 A sturdy four-plate arm design ensures strength and durability.
- 3 The new generation of JCB 4-6 ton excavators feature 100 percent steel bodywork.

Dig-end durability.

- 4 The optional, heavy-duty swing bracket provides safe routing for excavator hoses and features re-bushable pivots for extended service life.
- 5 A heavy duty boom cylinder guard and optional arm and crowd ram guards provide exceptional protection for critical components.



Quality componentry.

- 6** The cab door folds back to fit within the counterweight length, keeping it out of harms way when open.
 - 7** The hydraulic system features "O-Ring Face Seal" (ORFS) hydraulic fittings for optimal seal efficacy.
 - 8** High-quality 15.7" (400 mm) rubber tracks, with interlocking links, perform in even the most arduous conditions.
- Optional 15.7" (400 mm) or 21.7" (550 mm) steel tracks are pre-drilled to accept rubber pads. Optional Bridgestone GeoGrip™ Road Liner Pads allow individual segments to be replaced as needed.
- 9** The JCB 4-6 ton excavators feature the industry's best components, including JCB Diesel by Kohler engines, Nachi and Bosch-Rexroth hydraulic components and Bridgestone tracks.

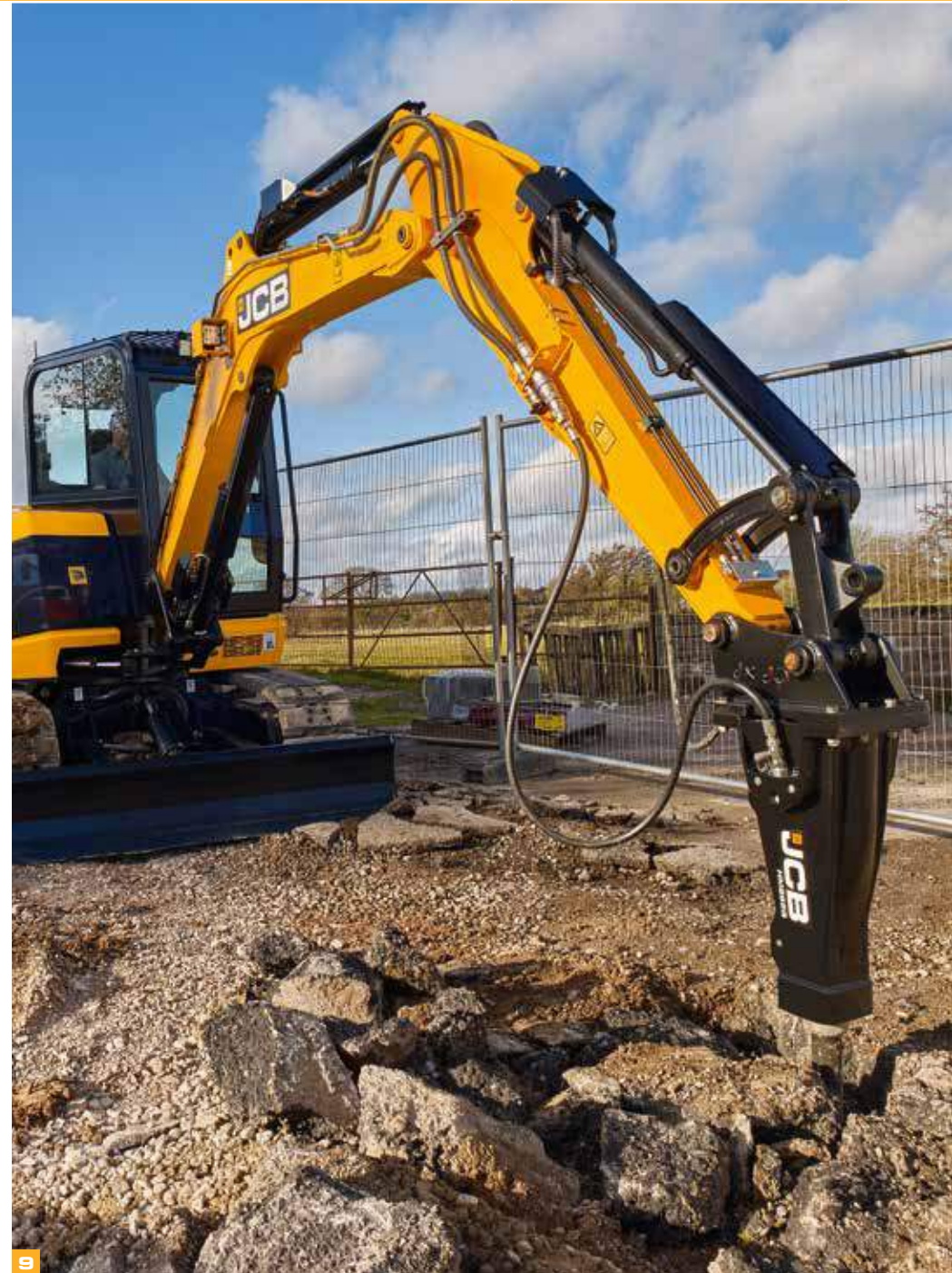

NEW GENERATION CONTROL.

THE NEW GENERATION OF JCB COMPACT EXCAVATORS PLACES GREAT EMPHASIS ON ERGONOMICS, EASE-OF-USE AND OPERATOR COMFORT, TO BOOST PRODUCTIVITY TO NEW LEVELS.

Comfort and control.

1 The spacious cabs of the new generation of JCB compact excavators are easily accessed via a wide-opening door. Inside, the cabs boast ample storage, a phone tray, stowage net and cup holder, all within easy reach.

2 Cabs feature a radio, 12 V phone charger, powerful heater with window demister, and a high-performance air-conditioning system* with eight air vents.

3 An innovative rotary controller and easy-touch switches are designed for low-effort, intuitive use.

4 The standard-fit, ergonomic, electro-hydraulic dozer control enables smooth and precise grading.

5 Alternate quickly between single and double-acting auxiliary flow with a convenient switch located within the cab.

* air conditioning optional

** 45Z-1 available with canopy only

A deluxe, fully-adjustable suspension seat provides great operator productivity. A heated, air-suspension option provides the ultimate in comfort and ergonomics.

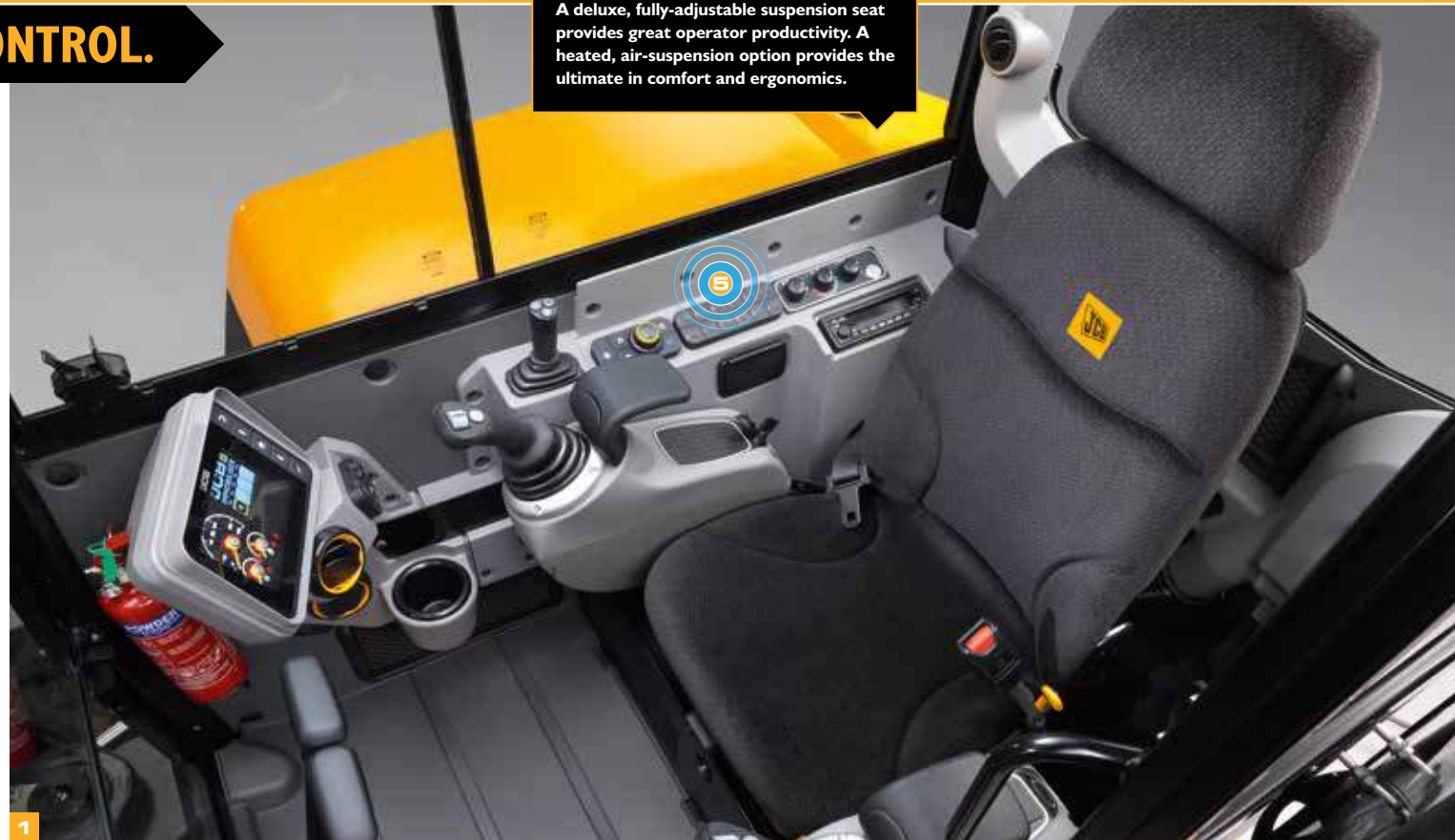

Superior instrumentation.

6 The digital screens in the new generation of JCB compact excavators have a simple user interface, customizable home screen and offer useful diagnostic information, all designed to boost productivity.

7 For increased safety, the JCB immobilizer eliminates the possibility of an unauthorized start. LiveLink* enables a fleet manager to impose geofencing and other operating restrictions.

Using the remote pin code management system for LiveLink and Immobilizer, the fleet manager can remotely authorize or deny the usage of the machine. Up to 14 individual pin codes can be programmed into the system, to enable individual operator preferences.

8 Hydraulic flow settings can be programmed and stored for specific attachments.

Service information and machine diagnostics--including service interval countdowns and service alerts--help to effectively manage machine status and plan for scheduled maintenance.

9 Fuel consumption information helps the operator to monitor the efficiency of the machine throughout the application.

* Refer to the standard and optional equipment table.



The switch panel and monitor are fitted with clearly identifiable, easy touch buttons.

NEW GENERATION PERFORMANCE.

THE NEW GENERATION OF JCB COMPACT EXCAVATORS INCLUDE INNOVATIVE DESIGN FEATURES TO IMPROVE VERSATILITY, PERFORMANCE AND PRODUCTIVITY.

Potent performance.

1 The new generation of 4-6 ton JCB compact excavators feature a JCB Diesel by Kohler Tier 4 final engine, with diesel oxidation catalyst (DOC), turbocharger and intercooler, delivering 48 hp and 221 lb-ft of torque at just 2,000 RPM.

2 Tracking performance is smooth and precise, enabling exceptional dozer capabilities and fast travel times. Auto kick-down motors adapt automatically to changes in terrain, for improved productivity and less operator fatigue.

Digging down.

3 By perfectly matching the excavator boom and arm, JCB offers optimal dig-end geometry. This enables fast cycle times and dipper tearout forces of up to 6,519 lbf, for unmatched productivity.

ZTS or CTS?

4 The JCB 4-6 ton excavator range includes zero tail swing (ZTS) and conventional tail swing (CTS) machines to suit any application. ZTS offers greater maneuverability within confined job sites, whereas CTS machines offer greater stability, lifting capacity and a larger dig end.



Bucket rotation is 181 degrees for maximum material retention during truck loading. Arm lengths are available from 5.4-7.3 feet, to suit any application.

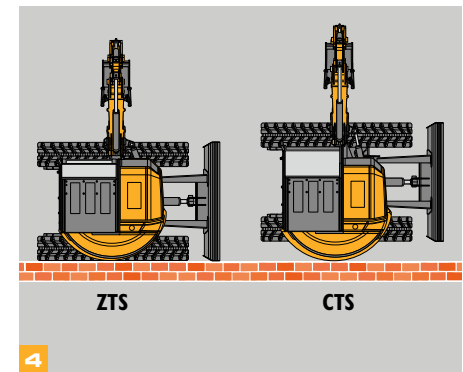

Hydraulic innovation.

4 A premium, closed-center hydraulic system enables improved flow sharing for smooth, precise and balanced multi-functioning.

5 The programmable twin auxiliary lines provide high and optional low hydraulic flow to operate an array of attachments. Both auxiliary lines are electronically proportional controlled and fully adjustable for optimum attachment control.

6 The optional 4-way dozer can be angled right and left. When combined with the dozer float function, this makes leveling and backfilling easy, even on inclines or uneven terrain.

Versatility attached.

7 Choose from a range of JCB eco buckets, designed to help save fuel. JCB attachments provide exceptional performance, full warranty compliance and optimal fit and operation.

8 An optional factory-fitted hydraulic 'quick coupler' enables faster attachment changes.

A optional tilt/rotate-ready installation enhances productivity and versatility.

The JCB hydraulic quick coupler works with a range of bucket pin centers, and is compatible with attachments from most excavator manufacturers in this weight class.

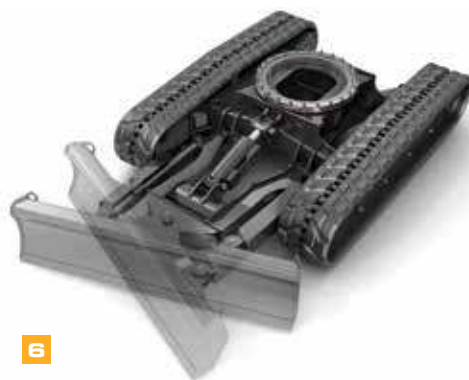

6



7



8

NEW GENERATION SAFETY.

SAFETY WAS THE FIRST PRIORITY WHEN DESIGNING THE NEW GENERATION OF JCB COMPACT EXCAVATORS. OWNERS, OPERATORS AND OTHERS ON THE WORK SITE WILL BENEFIT FROM A RANGE OF INNOVATIVE JCB SAFETY ENHANCEMENTS.

Maximum protection.

1 The cabs on the new generation of JCB excavators are fully ROPS and TOPS compliant. For increased protection, impact protection glass is an available option.

2 The unique JCB 2GO system requires two separate inputs, ensuring that the hydraulic system can only be operated when in a safe lockable position.

3 Our unique 2GO system ensures your compact excavator hydraulics can only be operated in a safe lockable position via two separate inputs.

As an optional safety feature, hydraulics can only be activated when the operator is seated and the seatbelt is buckled.

4 Hose burst check valves (HBCVs) are available for the boom, dozer and arm, with an overload screen display.

5 The monitor includes a load monitor with indicator lights ranging from green to red. If the overload point is exceeded, a buzzer sounds and the red indicators flash to warn the operator.



1



4



2



3



5

Safely does it.

- 6** A wide frame and low center of gravity enhances stability.
- 7** Optional work light guards protect vulnerable components during hazardous applications.
- 8** Optional LED lights accommodate the 'follow me home' function. When selected, the lights will remain on for three minutes after the machine is switched off, illuminating the work site so the operator can safely leave.
- 9** The new generation of JCB 4-6 ton compact excavators offer new levels of visibility--with a 70/30 front screen split--for easy, safe trench digging and maneuvering.



NEW GENERATION SERVICE.

JCB COMPACT EXCAVATORS ARE DESIGNED EASY SERVICING, TO ENABLE MAXIMUM PRODUCTIVITY AND MINIMUM DOWNTIME.

At your service.

- 1 Graphite impregnated bronze bushes allow best-in-class, 500-hour greasing intervals.
 - 2 An open-frame undercarriage and sloping track legs facilitate easy cleaning.
 - 3 Dozer hoses terminate at the bulkhead, for easy replacement when necessary.
 - 4 The wide-opening, all-steel hood and external fuel indicator make it easy to fill the tank from ground level. An optional refueling pump with auto-stop reduces spillages and enhances safety.
 - 5 Removing the cab floor is simple and provides access to key components, such as the main control valve spools.
 - 6 Anti-slip cast tread plates provide safe access and bodywork protection.
 - 7 The removable floor mat allows for easy cleaning.
- Boom-swing and auxiliary controls are mounted on the joystick, and the track pedals fold up when necessary, to free up floor space.
- 7 Hydraulic hoses are color-coded for easy identification.



NEW GENERATION EFFICIENCY.

COUNT ON THE NEW GENERATION JCB 48Z-I, 55Z-I AND 57C-I COMPACT EXCAVATORS TO KEEP OPERATING COSTS TO A MINIMUM.

Dynamic engine design.

1 A below-idle feature reduces engine speed when the operator's armrest is raised, for better fuel economy and lower noise levels.

2 Activate 'One-Touch-Idle' by pressing the new rotary controller dial, to quickly reduce engine revs and conserve fuel. Programmable auto idle can also be activated after the controls have been inactive for a period of time.

3 Engine speed can be controlled with four different power bands--light, eco, heavy and heavy plus--to easily set to optimum hydraulic flow for the selected attachment.

4 The patented, low-pressure return-line circuit further improves fuel efficiency by reducing demand on the hydraulic pump.

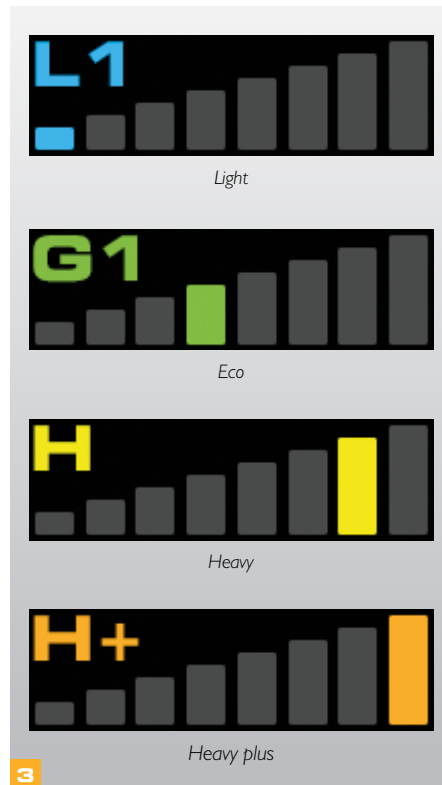

LIVELINK, WORK SMARTER.

LiveLink keeps track of each machine's efficiency, so you get the best value for money.



- Manage your fleet anywhere
- Drive down cost
- Improve productivity
- Fuel level and consumption*
- Customized reports by day / week / month

**For machines with electronic engine management system only*

LiveLink sends service alerts and diagnostic warnings to ensure your machine's maximum uptime.



- Machine health alerts
- Machine service alerts
- Accurate hours recorded
- Detailed machine history
- Maintenance planning

LiveLink reports machine's exact location, movement and activity offering greater protection against theft.



- Pinpoint machine location
- 24/7 update on your phone/tablet
- Real-time curfew alerts
- Real-time geofence alerts
- Back-up battery
- Tow-away alert



Peace of mind

Machine Servicing Agreement



Enhanced Dealer Support

JCB LiveLink

Note: Please consult your local dealer for LiveLink availability.

VALUE ADDED.

WHATEVER YOU NEED AND WHEREVER YOU ARE, JCB'S DEPENDABLE NORTH AMERICAN DEALER NETWORK IS HERE TO MAKE SURE YOUR MACHINERY PERFORMS TO ITS FULL POTENTIAL.



1

1 JCB Technical Support Service provides instant access to factory expertise, day or night

JCB's Finance team is always on hand to provide fast, flexible, competitive quotes.

2 The global network of JCB Parts Centers is a model of efficiency. With 16 regional bases, we can deliver around 95 percent of all parts anywhere in the world within 24 hours. Our genuine JCB parts are designed to work in perfect harmony with your machine for optimum performance and productivity.



2

3 JCB Yellow Shield offers comprehensive extended warranties and service agreements, as well as service-only or repair and maintenance contracts. JCB maintenance teams offer competitive labor rates and no-obligation quotes.

Note: JCB LIVELINK and JCB YELLOW SHIELD may not be available in your region. Please check with your local JCB dealer.



3

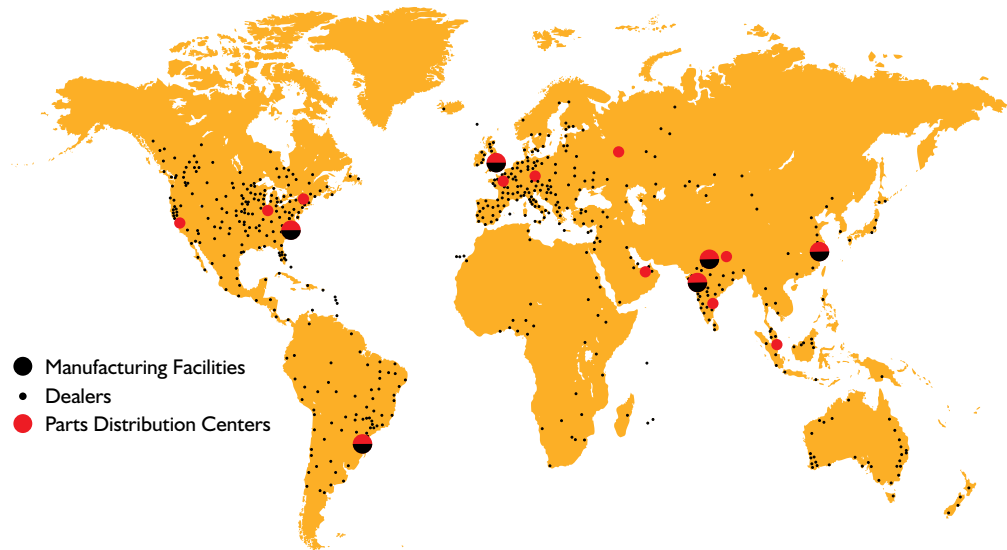

STATIC DIMENSIONS

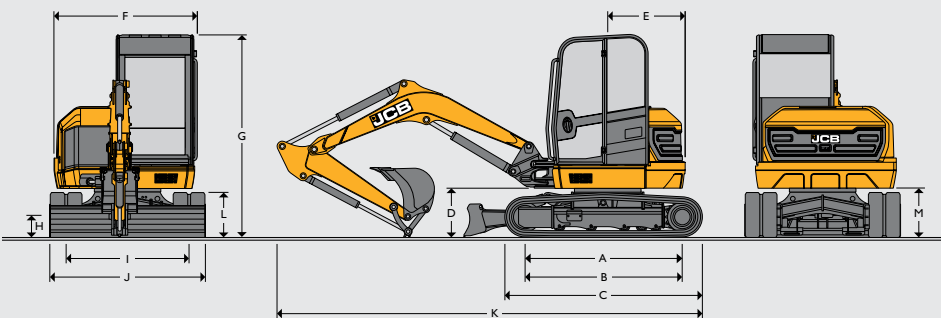

Machine model		45z-1	48z-1	55z-1	57c-1
A	Sprocket idler centers	ft-in (mm)	6-6 (2,000)	6-5 (1,985)	
B	Track length on ground	ft-in (mm)	6-6 (2,000)		
C	Undercarriage overall length – rubber	ft-in (mm)	8-2 (2,490)		
	Undercarriage overall length – steel	ft-in (mm)	N/A	8-2 (2,490)	
D	Kingpost clearance	ft-in (mm)	2-0 (631)		
E	Tailswing radius	ft-in (mm)	3-2 (975)	3-3 (1,000)	4-3 (1,300)
F	Overall width of superstructure	ft-in (mm)	5-11 (1,820)		6-0 (1,845)
G	Height over cab	ft-in (mm)	8-4 (2,561)		
H	Ground clearance	ft-in (mm)	1-0 (300)		
I	Track gauge	ft-in (mm)	5-1 (1,550)		
J	Width over tracks	ft-in (mm)	6-2 (1,900)	6-4 (1,950)	
K	Transport length with standard dipper	ft-in (mm)	17-6 (5,353)	18-1 (5,518)	18-0 (5,495)
L	Track height	ft-in (mm)	1-10 (560)		
M	Counterweight clearance	ft-in (mm)	2-0 (618)		

ENGINE

Machine model		Standard
Machine model		45z-1, 48z-1, 55z-1, 57c-1
Model		Tier 4 Final KDI 1903
Fuel		Diesel
Cooling		Water cooled
Gross power ISO 14396	hp (kW)	48.3 (36) @ 2,200 RPM
Net power	hp (kW)	44.8 (33.4) @ 2,200 RPM
Gross torque ISO 14396	Nm	225 @ 1,500 RPM
Displacement	cc	1,903
Gradeability	degrees	30
Starter motor	hp (kW)	2.9 (2)
Battery	volt / amps	12V / 75 Ah
Alternator	amps (with A/C)	100

UNDERCARRIAGE

Machine model		45z-1	48z-1	55z-1	57c-1
No. of top rollers		1			
No. of bottom rollers		4			
Track width rubber (STD)	in (mm)	13.7 (350)	15.7 (400)		
Track width steel	in (mm)	N/A	15.7 (400)		
Ground bearing pressure (400 mm tracks)	psi (kg/cm ²)	4.4 (0.32)	4.2 (0.30)	4.9 (0.35)	5.1 (0.36)
Ground bearing pressure (550 mm tracks)	psi (kg/cm ²)	N/A	3.1 (0.22)	3.5 (0.25)	3.7 (0.26)
Track tensioning		Grease			
Travel speed – low	mph (kph)	1.8 (3)			
Travel speed – high	mph (kph)	2.8 (4.6)			
Tractive effort	lbf (kN)	7,755 (34.5)	8,025 (35.7)	8,565 (38.1)	8,992 (40)

HYDRAULIC SYSTEM

Machine model		45z-1	48z-1	55z-1	57c-1
Pump	cc	63			
Nominal output @ 2000 RPM	gpm (lpm)	33.2 (126)			
Excavator/track main relief pressure	psi (bar)	3,480 (240)		3,843 (265)	
Slew main relief pressure	psi (bar)	3,133 (216)			
Auxiliary hydraulic pressure (Low)	psi (bar)	3,132 (190)			
Auxiliary hydraulic pressure (High)	psi (bar)	2,755 (190)			
Auxiliary hydraulic flow (Low)	gpm (lpm)	10.6 (40)			
Auxiliary hydraulic flow (High)	gpm (lpm)	23.7 (90)			
Hydraulic pump		Piston			

WEIGHTS

Machine model		45z-1	48z-1	55z-1	57c-1
Operating weight* (400 mm rubber tracks)	lb (kg)	9,878 (4,481)	10,564 (4,792)	11,830 (5,366)	12,087 (5,483)
Shipping** weight (400 mm rubber tracks)	lb (kg)	9,605 (4,357)	10,277 (4,662)	11,543 (5,236)	11,801 (5,353)
With FOGs guard – stage 1	lb (kg)	N/A	+ 35 (+ 16)		
Aircon (includes FOGS guard-stage 1)	lb (kg)	N/A	+ 134 (61)		+ 145 (66)
With steel tracks (400 mm)	lb (kg)	N/A	+ 339 (+ 154)		
With steel tracks (550 mm)	lb (kg)	N/A	+ 608 (+ 276)		
With Geo grip tracks (400 mm)	lb (kg)	N/A	+ 388 (+ 176)		
With 4 way dozer	lb (kg)	N/A	+ 482 (+ 219)		
Hydraulic quickhitch installation weight	lb (kg)	N/A	+ 159 (+ 72.5)		

* Operating weight to ISO 6016 including cab, rubber tracks, standard arm, 600 mm bucket, full tanks and a 165 lb operator.

* Operating weight with canopy only, 350 mm tracks, 1,450 mm dipper, 600 mm bucket, full tanks, 165 lb operator.

** Shipping weight to ISO 6016 is mass of the base machine without an operator, with the fuel level at 10% of tank capacity.

** Shipping weight with canopy only, base machine without an operator, with the fuel level at 10% of tank capacity.

SERVICE CAPACITIES

Machine model	45Z-1	48Z-1	55Z-1	57C-1
Fuel tank	gallon (litres) 20 (76)			
Engine coolant	gallon (litres) Tier 4: 2.4 (9.2)			
Engine oil	gallon (litres) Tier 4: 2.1 (8) max			
Hydraulic system	gallon (litres) 26.4 (100)		29.5 (112)	
Hydraulic tank	gallon (litres) 14.5 (55)		16.4 (62)	

OPERATOR ENVIRONMENT

Machine model	45Z-1	48Z-1	55Z-1	57C-1
Cab/canopy height	ft-in (mm) 8-4 (2,551)			
Cab/canopy height with FOGS guard LEVEL I	ft-in (mm) N/A		8-4 (2,575)	
Cab/canopy length	ft-in (mm) 4-2 (1,291)		4-10 (1,491)	
Cab/canopy width	ft-in (mm) 3-4 (1,020)			
Door aperture width	ft-in (mm) 1-9 (552)		1-11 (595)	

STANDARD EQUIPMENT

Fully-glazed ROPS & TOPS certified cab. Programmable, intermittent wiper with wash/wipe. Three-speed heater/demister with four adjustable air vents. Color LCD display. Digital clock. Internal lockable toolbox. Cup holder. Coat hook. Stowage net. 12 V accessory socket. Interior light. Full audio/visual warning systems. Auto idle throttle. Below idle system. One touch idle. Four power bands (light, eco, heavy and heavy plus). ISO servo controls with electro-hydraulic dozer lever. Electro-proportional thumb controlled high flow single acting auxiliary, 10 selectable auxiliary flow rates. Joystick-mounted hammer switch. Neutral start. Full control isolation. "2GO" hydraulic isolation. Mid-back suspension seat. Removable floor mat. Beacon-ready kit. Two-speed tracking. Auto-kick down track motors. 15.7" (400 mm) short-pitch rubber tracks. Double element air cleaner. Heavy-duty alternator. Heavy-duty battery. Hydraulic slew braking with disc type park brake. ORFS hydraulics. Color-coded hydraulic hoses. 500-hour dig-end greasing intervals. Heavy-duty boom cylinder guard. Protected boom work light. Quick-release auxiliary couplers. 100% steel bodywork. Dedicated tie down and lifting points. JCB LiveLink.

45Z-1 is canopy only – no heater or vents. 350 mm (13.8") rubber tracks. Mid-black vinyl seat. Ram. Guard to boom only.

OPTIONAL EQUIPMENT

Air-conditioning with 8 adjustable air vents. Adjustable sun visor. FOPS guard stage 1. 15.7" (400 mm) or 21.7" (550 mm) steel tracks. 15.7" (400 mm) Geo GripRoad Liner tracks. Fan guards. Battery isolator (standard for EU). High back seat or deluxe heated high back air-suspension seat. Radio installation. Electro-proportional thumb controlled low-flow auxiliary. Hose burst check valve lifting kit (dozer, boom & dipper). Bucket-to-grab change over valve. Mechanical quick coupler. Hydraulic quick hitch. Hydraulic quick hitch-ready pipework. General purpose digging eco bucket. Ditch/grading eco buckets. Hydraulic hammer. Rotating/strobe beacon. Travel alarm. Toolkit. Grease gun and cartridge. Fire extinguisher. Exterior cab-mounted mirrors. Interior mirror. Electric refuelling pump. JCB immobilizer (unique key or keypad system). Dozer float. Four-way angled dozer blade. Dual-pattern controls (ISO/SAE change-over). Thumb-ready dipper. Special paint options. LED or halogen work lights (either; with follow me home function). ROPS & TOPS certified canopy. Tilt/rotate-ready installation. Media socket. Radio ready kit. Work light guards (cab). Arm/crowd ram guards. Rear view camera. Rear view angled mirror. Impact protection front screen. Bushed king post. Electronic single/double-acting change over valve. JCB LiveLink.

WORKING RANGE

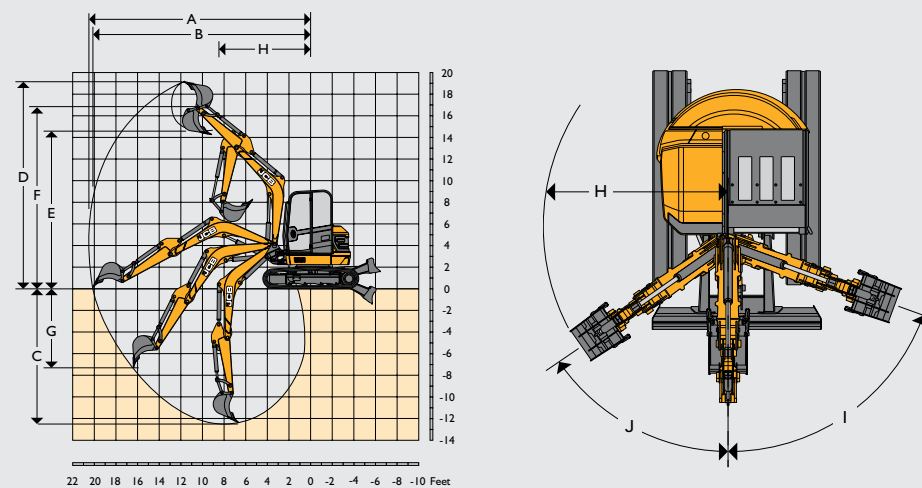













		45	48Z-1	55Z-1	57C-1
Arm length	ft-in (mm)	4-9 (1,450)	5-1 (1,570)	5-11 (1,820)	
Boom length	ft-in (mm)	8-10 (2,700)	9-4 (2866)		
A	Maximum digging reach	ft-in (mm) 19-2 (5,846)	20-0 (6,119)	20-6 (6,260)	
B	Maximum digging reach on ground	ft-in (mm) 18-8 (5,714)	19-8 (5,995)	20-1 (6,144)	
C	Maximum digging depth – dozer up	ft-in (mm) 10-10 (3,327)	11-9 (3,606)	12-7 (3,856)	
	Maximum digging depth – dozer down	ft-in (mm) 11-11 (3,532)	12-7 (3,843)	13-4 (4,077)	
D	Maximum digging height	ft-in (mm) 17-8 (5,387)	18-6 (5,664)	19-2 (5,846)	
E	Maximum dump height	ft-in (mm) 13-1 (4,001)	14-0 (4,274)	14-7 (4,456)	
F	Maximum height to dipper nose pivot pin	ft-in (mm) 15-4 (4,679)	16-3 (4,970)	16-10 (5,152)	
G	Maximum vertical wallcut depth	ft-in (mm) 6-5 (1,971)	6-8 (2,052)	7-4 (2,254)	
H	Minimum front swing radius (no offset)	ft-in (mm) 8-6 (2,599)	8-7 (2,641)	8-6 (2,608)	
	Minimum front swing radius (fully offset)	ft-in (mm) 6-11 (2,123)	7-1 (2,160)	7-0 (2,155)	
I	Boom swing left	degrees	70		
J	Boom swing right	degrees	55		
	Bucket rotation	degrees	181		
	Arm rotation	degrees	121		
	Bucket tearout	lbf (kN)	8,542 (38)	9,442 (42)	
	Arm tearout	lbf (kN)	4,945 (22)	6,519 (29)	5,845 (26)
	Slew speed	rpm	8.3		

















DOZER

Machine model	45Z-1	48Z-1	55Z-1	57C-1
Dozer length	ft-in (mm) 3-8 (1,141)			
Maximum height above ground	ft-in (mm) 1-5 (433)			
Dig depth below ground	ft-in (mm) 1-6 (464)			
Approach angle	degrees 31 (31)			
Width	ft-in (mm) 6-5 (1,962)			
Height	ft-in (mm) 1-3 (400)			

LIFT CAPACITIES – 13.78IN (350 MM) RUBBER TRACKS, 106.2IN (2,700 MM) BOOM, 57 IN (1,450 MM) ARM, NO BUCKET. 45Z-1

Load Point	6'6"			9'10"			13'1"			Capacity at maximum reach			
													
Height	Dozer Up	Dozer Down	Over Side	Dozer Up	Dozer Down	Over Side	Dozer Up	Dozer Down	Over Side	Dozer Up	Dozer Down	Over Side	ft-in (m)
ft-in	lbs (kg)	lbs (kg)	lbs (kg)	lbs (kg)	lbs (kg)	lbs (kg)	lbs (kg)	lbs (kg)	lbs (kg)	lbs (kg)	lbs (kg)	lbs (kg)	ft-in (m)
11-6 (3.5)							1,893 (859)	1,920 (871)	1,268 (575)	1,638 (743)	1,984 (900)	1,116 (506)	13-9 (4.2)
9-10 (2.77)							1,867 (847)	1,911 (867)	1,252 (568)	1,440 (653)	1,956 (887)	974 (442)	14-9 (4.5)
8-2 (2.5)				2,205 (1,000)	2,220 (1,007)	2,235 (1,014)	1,960 (889)	2,019 (916)	1,239 (562)	1,349 (612)	1,997 (906)	884 (401)	15-3 (4.7)
6-7 (2.0)				2,727 (1,237)	2,765 (1,254)	1,931 (876)	1,704 (773)	2,198 (997)	1,202 (545)	1,221 (554)	2,041 (926)	855 (388)	15-9 (4.8)
4-11 (1.3)				2,597 (1,178)	3,213 (1,457)	1,817 (824)	1,680 (762)	2,359 (1,070)	1,150 (522)	1,219 (553)	2,048 (929)	825 (374)	16-1 (4)
3-3 (1.0)				2,530 (1,148)	3,622 (1,643)	1,698 (770)	1,645 (746)	2,478 (1,124)	1,142 (518)	1,206 (547)	2,072 (940)	818 (371)	16-1 (4)
1-7 (0.5)				2,452 (1,112)	3,840 (1,742)	1,682 (763)	1,656 (751)	2,703 (1,226)	1,224 (555)	1,219 (553)	2,125 (964)	818 (371)	16-1 (4)
0 (0)	3,741 (1,697)	5,302 (2,405)	2,515 (1,141)	2,090 (948)	3,311 (1,502)	1,644 (746)	1,627 (738)	2,751 (1,248)	1,116 (506)	1,272 (577)	2,154 (977)	858 (389)	15-9 (4.8)
-1-7 (-0.5)	3,971 (1,801)	5,523 (2,505)	2,716 (1,232)	2,445 (1,109)	4,041 (1,833)	1,607 (729)	1,618 (734)	2,767 (1,255)	1,096 (497)	1,327 (602)	2,198 (997)	904 (410)	15-1 (4.6)
-3-3 (-1.0)	4,200 (1,905)	5,258 (2,385)	2,862 (1,298)	2,432 (1,103)	3,769 (1,710)	1,592 (722)	1,613 (732)	2,599 (1,179)	1,100 (499)	1,407 (638)	2,051 (930)	974 (442)	14-3 (4.4)

LIFT CAPACITIES – 400 MM RUBBER TRACKS, 2,700 MM BOOM, 1,450 MM ARM, NO BUCKET. 48Z-1

Load Point	6'6"			9'10"			13'1"			16'4"			Capacity at maximum reach				
																	Distance
Height	Dozer Up	Dozer Down	Over Side	Dozer Up	Dozer Down	Over Side	Dozer Up	Dozer Down	Over Side	Dozer Up	Dozer Down	Over Side	Dozer Up	Dozer Down	Over Side	ft-in (m)	
ft-in	lbs (kg)	lbs (kg)	lbs (kg)	lbs (kg)	lbs (kg)	lbs (kg)	lbs (kg)	lbs (kg)	lbs (kg)	lbs (kg)	lbs (kg)	lbs (kg)	ft-in (m)	lbs (kg)	lbs (kg)	lbs (kg)	ft-in (m)
13-2 (4.0)													1,856 (842)	1,856 (842)	1,336 (606)		12-9 (3.9)
11-6 (3.5)							1,878 (852)	2,114 (959)	1,283 (582)				1,629 (739)	1,728 (784)	1,105 (501)		14-1 (4.3)
9-10 (2.8)				2,624 (1,190)	2,624 (1,190)	2,033 (922)	1,867 (847)	2,125 (964)	1,272 (577)				1,435 (651)	1,713 (777)	966 (438)		15-1 (4.6)
8-2 (2.3)				2,912 (1,321)	3,179 (1,442)	1,925 (873)	1,834 (832)	2,240 (1,016)	1,243 (564)				1,310 (594)	1,647 (747)	873 (396)		15-9 (4.8)
6-7 (2.0)				2,778 (1,260)	3,790 (1,719)	1,808 (820)	1,790 (812)	2,420 (1,098)	1,203 (546)				1,226 (556)	1,556 (706)	809 (367)		16-3 (4.9)
4-11 (1.3)				2,663 (1,208)	4,297 (1,949)	1,709 (775)	1,742 (790)	2,628 (1,192)	1,157 (525)	1,199 (544)	1,982 (899)	787 (357)	1,182 (536)	1,678 (761)	776 (352)		16-6 (5.0)
3-3 (1.0)				2,588 (1,174)	4,597 (2,085)	1,640 (744)	1,693 (768)	2,822 (1,280)	1,113 (505)	1,182 (536)	2,224 (1,009)	772 (350)	1,160 (526)	1,656 (751)	756 (343)		16-7 (5.0)
1-7 (0.5)				2,546 (1,155)	4,685 (2,125)	1,603 (727)	1,653 (750)	2,970 (1,347)	1,078 (489)	1,168 (530)	1,947 (883)	761 (345)	1,166 (529)	1,790 (812)	758 (344)		16-5 (5.0)
0 (0)				2,531 (1,148)	4,594 (2,084)	1,590 (721)	1,627 (738)	3,040 (1,379)	1,052 (477)				1,199 (544)	1,909 (866)	778 (353)		16-0 (4.8)
-1-7 (-0.5)	4,354 (1,975)	4,354 (1,975)	1,415 (642)	2,535 (1,150)	4,332 (1,965)	1,594 (723)	1,612 (731)	3,009 (1,365)	1,038 (471)				1,265 (574)	2,033 (922)	822 (373)		15-6 (4.7)
-3-3 (-1.0)	5,496 (2,493)	5,498 (2,494)	1,425 (646)	2,560 (1,161)	3,871 (1,756)	1,616 (733)	1,614 (732)	2,840 (1,288)	1,041 (472)				1,385 (628)	2,187 (992)	899 (408)		14-8 (4.5)
-4-11 (-1.3)	5,549 (2,517)	6,408 (2,907)	1,444 (655)	2,610 (1,184)	3,086 (1,400)	1,660 (753)	1,638 (743)	2,403 (1,090)	1,065 (483)				1,587 (720)	2,224 (1,009)	1,034 (469)		13-5 (4.1)
-6-7 (-2.0)	5,002 (2,269)	5,002 (2,269)	1,476 (670)										1,980 (898)	2,112 (958)	1,290 (585)		11-9 (3.6)
-8-2 (-2.5)													1,662 (754)	1,662 (754)	1,662 (754)		9-3 (2.8)

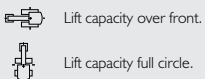

Notes:

1. Lifting capacities are based on ISO 10567, that is: 75% of minimum tipping load or 87% of hydraulic lift capacity, whichever is the less. Lifting capacities marked* are based on hydraulic capacity.
2. Lift capacities assume that the machine is on firm level ground and equipped with an approved lifting point.
3. A bucket must be fitted when lifting, the weight of this bucket must be deducted from the above lift capacities.
4. Lift capacities may be limited by local regulations. Please refer to your dealer.



ONE COMPANY, MORE THAN 300 MACHINES.

Compact Excavator 45z-1/48z-1/55z-1/57c-1

Operating weight: 9,886 lb (4,475 kg) – 12,087 lb (5,483 kg) Net engine power: 48 hp (36 kW)

JCB North American

2000 Bamford Blvd., Pooler, Georgia, 31322 Tel: (912) 447-2000

Download the very latest information on this product range at www.jcb.com

JCB inc. All rights reserved. No part of this publication may be reproduced, stored in a retrieval system, or transmitted in any form or by any other means, electronic, mechanical, photocopying or otherwise, without prior permission from JCB inc. All references in this publication to operating weights, sizes, capacities and other performance measurements are provided for guidance only and may vary dependant upon the exact specification of machine. They should not therefore be relied upon in relation to suitability for a particular application. Guidance and advice should always be sought from your JCB Dealer. JCB reserves the right to change specifications without notice. Illustrations and specifications shown may include optional equipment and accessories. The JCB logo is a registered trademark of J C Bamford Excavators Ltd.

Your nearest JCB Dealer

